

Data Sheet

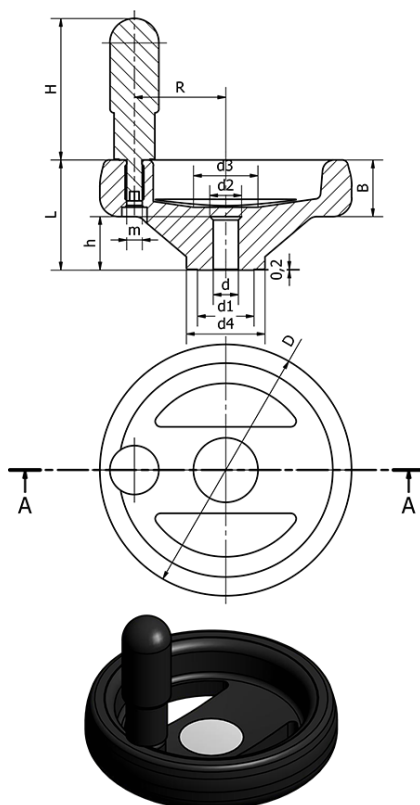

Article number: 2301079261R
Description: E+G Handwheel
VRTP.160-P+I-SST-14
Note: Plastic

Measures



= -	d H7	= 14
B = 25	H	= 27
Code = 79261-R	L	= 51
D = 160	R	= 65
d1 = 26	Type	= VRTP.160-P+I-SST-14
d2 = 24	Weight (g)	= 356
d3 = 32		
d4 = 40		